

# GD 930 GD 930S2

---

Model:  
GD 930  
GD 930 S2



Part List US-English

26-05-2009

# Table of Contents

GD 930 GD 930S2

<b>Fan unit and cord</b>	<b>3</b>
<b>Filters and upper parts</b>	<b>5</b>
<b>Wheel and lower parts</b>	<b>7</b>
<b>Nozzles Ø 32 mm</b>	<b>9</b>
<b>Hose and tubes</b>	<b>11</b>
<b>Power brush UZ 984 line drawing</b>	<b>13</b>

# Fan unit and cord

GD 930 GD 930S2

26-05-2009

Part List ID

B0333

3

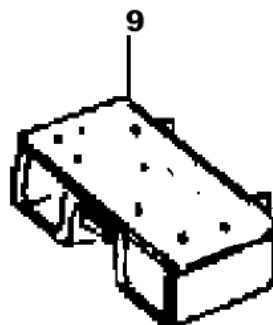
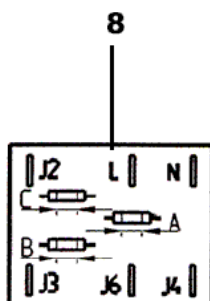
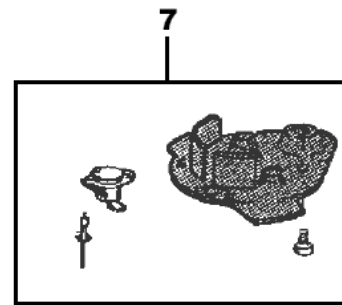
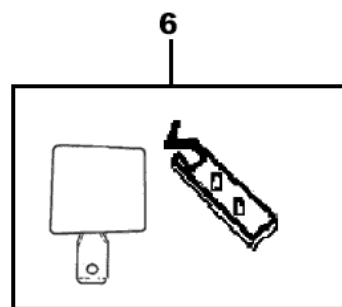
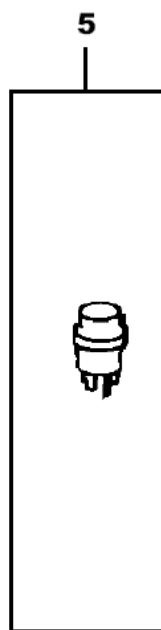
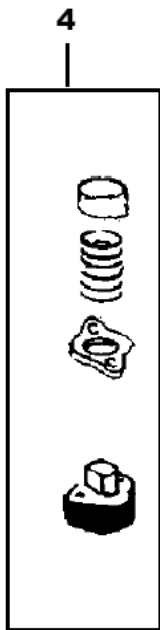
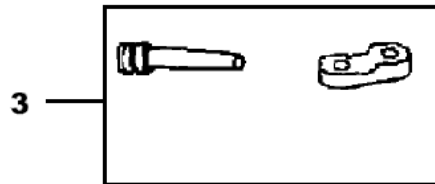
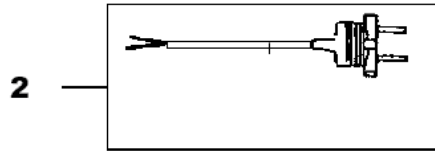
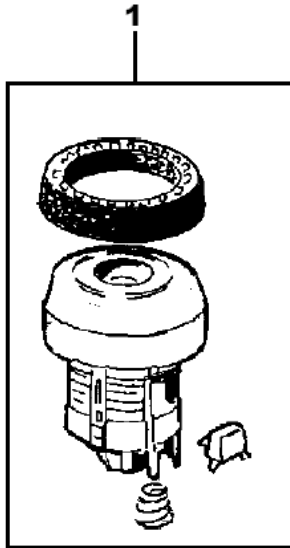

# Fan unit and cord

GD 930 GD 930S2

26-05-2009

Part List ID

B0333

4

Pos	Part no.	Qty	Description	EAN
1	140 7902 500	1	FAN UNIT KIT DOMEL 230V	7319519605
1	140 7902 510	1	FAN UNIT KIT DOMEL 110-120V	7319519605
1	140 7902 520	1	FAN UNIT KIT DOMEL 240V	7319519605
1	140 7902 530	1	FAN UNIT KIT DOMEL 100V	7319519605
1	140 7902 540	1	FAN UNIT KIT DOMEL 127VFAN UNIT, SUSPENSION RING	7319519605
2	140 6423 500	1	CORD EU L 15M	7319519631
2	140 6423 510	1	CORD EU L 10M	7319519631
2	140 6423 520	1	CORD KIT CH L 15M	7319519631
2	140 6423 530	1	CORD UK L 15M	7319519631
2	140 6423 540	1	CORD UK L 10M	7319519631
2	140 6423 550	1	CORD US PLUG L 15M	7319519631
2	140 6423 560	1	CORD US L 10M GROUNDED	7319519631
2	140 6423 570	1	CORD JP L 15M	7319519631
2	140 6423 580	1	CORD AU L 14M	7319519631
2	147 1042 000	1	CORD SET CHINA 15.5M	7319519659
3	140 7035 500	1	PROTECTION SLEEVE KIT	7319519631
3	140 7035 510	1	PROTECTION SLEEVE US KIT	7319519631
4	140 7033 500	1	SWITCH ON/OFF 930-SERIES	7319519632
5	140 7023 500	1	SWITCH SPEED FOR 930S2	7319519632
6	010 9678 500	1	OUTLET ELECTRICAL 230V	7319519632
6	140 7665 500	1	OUTLET ELECT.15A 250V	7319519632
7	140 7012 500	1	MOTOR PLATE GD/UZ930/S2	7319519632
7	140 7012 510	1	MOTOR PLATE GD 930/S2	7319519632
8	140 7024 500	1	BOARD ANTI STATIC	7319519632
9	140 7026 500	1	2S CIRCUIT BOARD 220-240V KIT	7319519629
9	140 7026 510	1	2S CIRCUIT BOARD 110-120V KIT	7319519629

# Filters and upper parts

GD 930 GD 930S2

26-05-2009

Part List ID

B0335

5

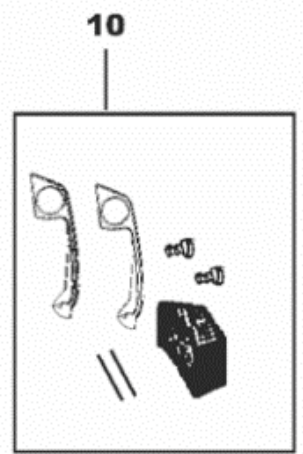
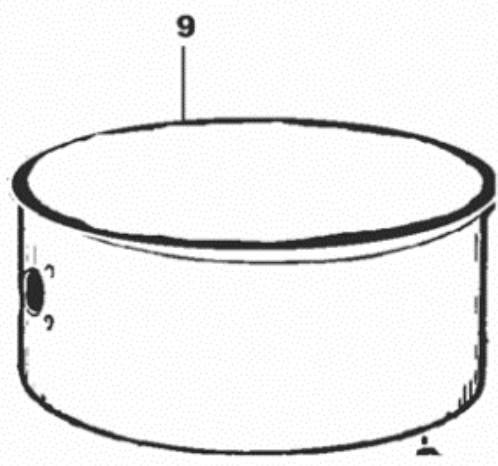
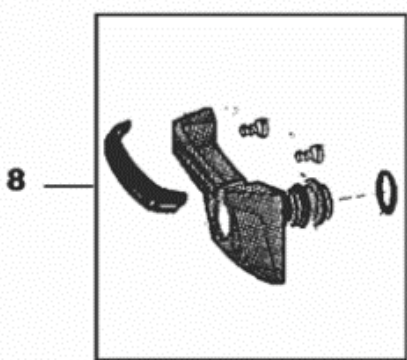
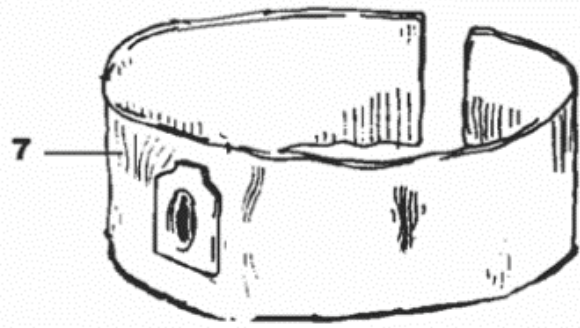
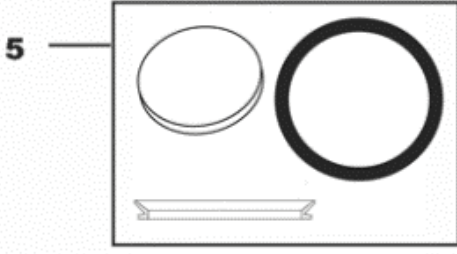
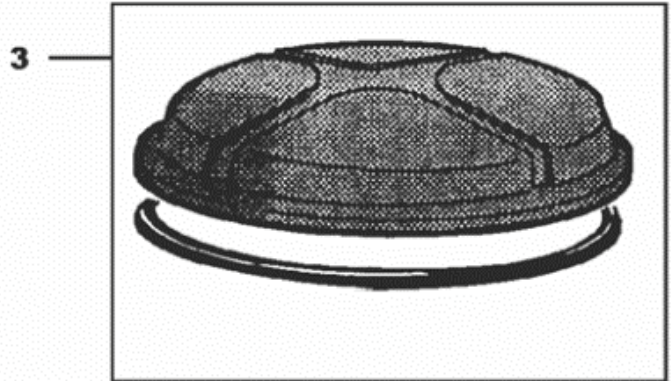
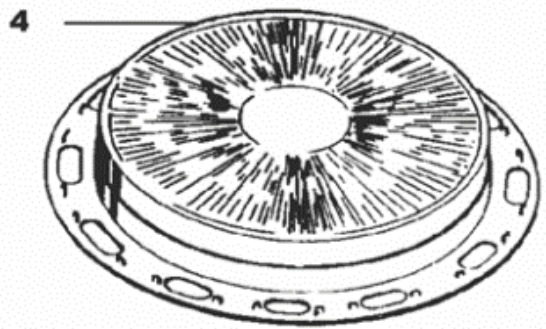
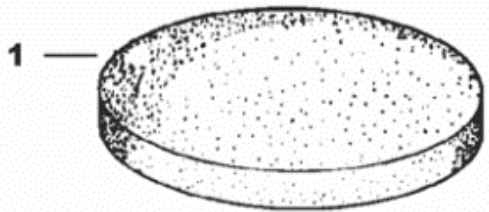

# Filters and upper parts

GD 930 GD 930S2

26-05-2009

Part List ID

B0335

6

Pos	Part no.	Qty	Description	EAN
0	140 7877 000	1	DECAL NILFISK GD 930	7319519603
1	140 1515 500	1	FILTER MAIN FOAM	7319519632
2	140 3260 500	1	FILTER PAPER 5-P	7319519632
3	140 7801 500	1	LID W/FILTER 930-SERIES	7319519632
3	140 7801 510	1	LID WITH HEPA FILTER	7319519632
4	140 2666 010	1	HEPA FILTER FOR GD 930	7319519371
5	140 1535 500	1	MOTOR PROTECTION	7319519632
6	140 7014 500	1	LOCKING DUSTBAG 3 PCS	7319519632
7	140 7015 040	1	DUST BAG (10 PCS)	7319519400
7	140 7019 500	1	CLOTH DUST BAG 1-P	7319519632
7	140 7313 020	1	DUST BAG HIGH FILTRATION 10-P	7319519408
8	140 7800 500	1	HANDLE GD 930/S2	7319519632
9	140 7020 510	1	CONTAINER CHROMED	7319519632
10	140 7832 500	1	LATCHES GD 930/S2	7319519632
NI	140 7784 000	1	BOX FOR GD 930	7319519601

NOTE: Container 140 7020 520 is replaced by container 140 7020 510.

# Wheel and lower parts

GD 930 GD 930S2

26-05-2009

Part List ID

B0337

7

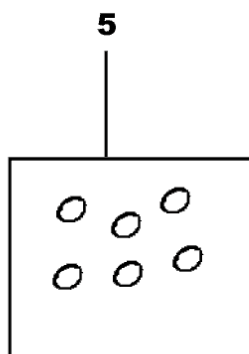
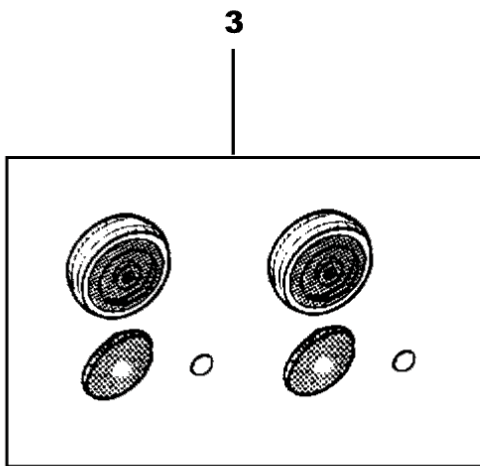
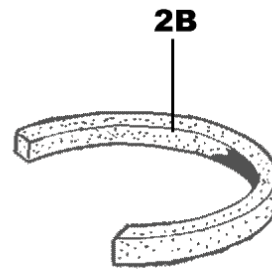
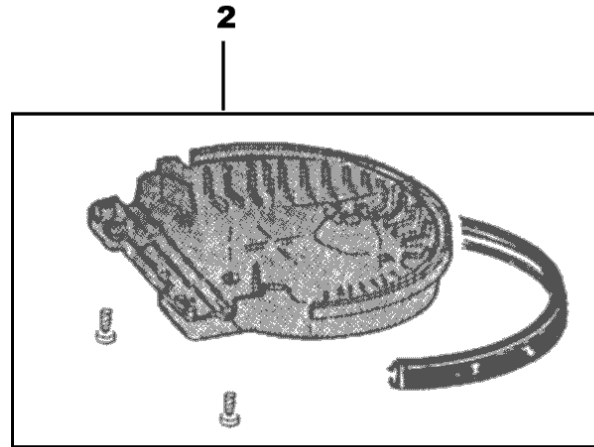
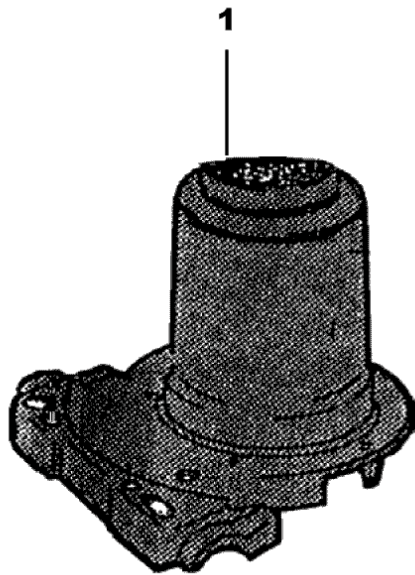

# Wheel and lower parts

GD 930 GD 930S2

26-05-2009

Part List ID

B0337

8

Pos	Part no.	Qty	Description	EAN
1	140 7010 500	1	STAND GD 930/UZ 930S	7319519632
1	140 7010 510	1	STAND GD 930S2/UZ 930S2	7319519632
1	140 7010 530	1	STAND GD/UZ 930S BLACK UL-LIST	7319519632
1	140 7010 540	1	STAND GD/UZ 930S2 BLACK UL-LIS	7319519632
2	140 7011 500	1	BASE BUMPER GD/UZ930S/S2	7319519632
2	140 7011 510	1	BASE BUMPER GD930/UZ930/S2	7319519632
3	140 5055 500	2	WHEEL REAR 2-P 930-SERIES	7319519632
4	140 7025 500	1	WHEEL FRONT 1-P	7319519632
5	140 5058 500	6	LOCK WASHER GD 930	7319519652
2B	140 7022 500	1	MUFFLER STRIP	7319519658

# Nozzles Ø 32 mm

GD 930 GD 930S2

26-05-2009

Part List ID

B0339

9

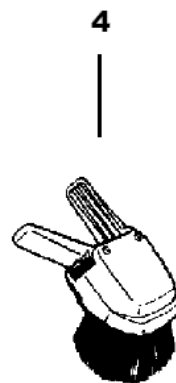
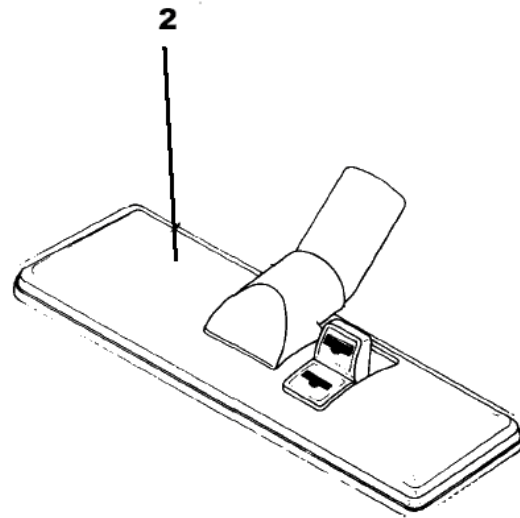
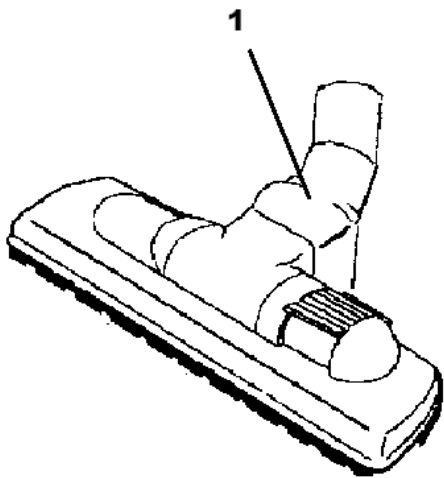

# Nozzles Ø 32 mm

GD 930 GD 930S2

26-05-2009

Part List ID

B0339

10

Pos	Part no.	Qty	Description	EAN
1	140 7087 500	1	NOZZLE COMBI D32 BLACK	7319519632
2	140 5634 500	1	COMBI NOZZLE 32 MM	7319519632
3	010 3098 500	1	CREVICE NOZZLE	7319519629
4	011 3104 500	1	SMALL COMBI NOZZLE	7319519629

# Hose and tubes

GD 930 GD 930S2

26-05-2009

Part List ID

B03311

11

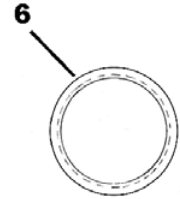
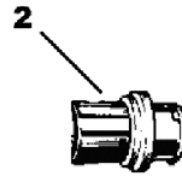
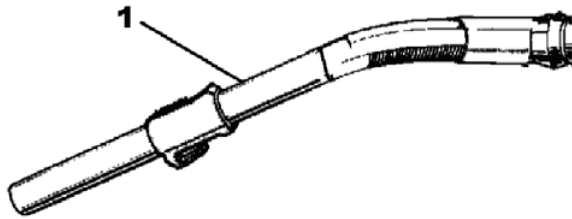

3

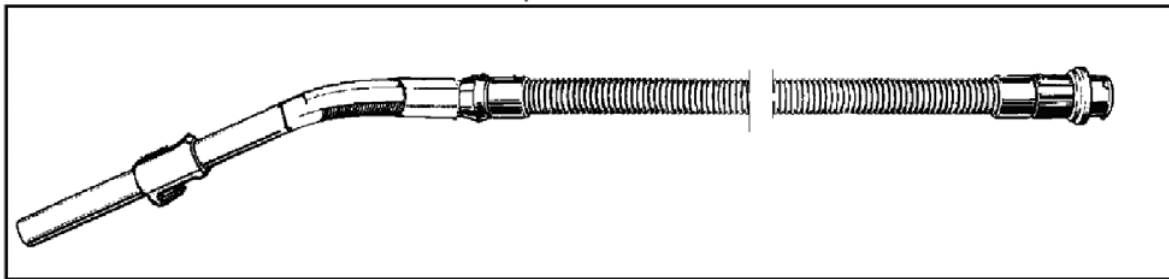

4



5



# Hose and tubes

GD 930 GD 930S2

26-05-2009

Part List ID

B03311

12

Pos	Part no.	Qty	Description	EAN
1	140 5116 500	1	HOSE HANDLE ALU/RUBBER DIAM.32	7319519632
2	140 3846 500	1	CUFF W.BAYONET COUPL.D32	7319519632
3	140 2782 500	1	HOSE ALU.HANDLE D32	7319519632
4	011 6431 500	1	EXTENSION TUBE ALUMINIUM	7319519631
5	011 8130 500	1	TELESCOPIC TUBE ALUMINIUM	7319519631
6	010 9299 540	1	GASKET CPL	7319519666